

## Silicon Carbide Schottky Diode

$V_{RRM}$	1700V
$I_F (133^\circ\text{C})$	30A
$Q_C$	231nC

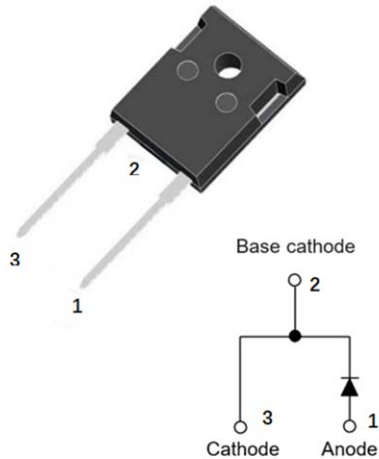

### Features

- Positive temperature coefficient
- Temperature-independent switching
- Maximum working temperature at 175 °C
- Unipolar devices and zero reverse recovery current
- Zero forward recovery current
- Essentially no switching losses
- Reduction of heat sink requirements
- High-frequency operation
- Reduction of EMI

### Typical Applications

Typical applications are in power factor correction(PFC), solar inverter, uninterruptible power supply, motor drives, photovoltaic inverter, electric car and charger.

### Mechanical Data

- **Package:** TO-247AC  
Molding compound meets UL 94 V-0 flammability rating, RoHS-compliant, halogen-free
- **Terminals:** Tin plated leads
- **Polarity:** As marked

### ■Maximum Ratings ( $T_C=25^\circ\text{C}$ Unless otherwise specified)

PARAMETER	SYMBOL	UNIT	VALUE
Device marking code			D117030NG1
Reverse voltage (Repetitive peak) @ $T_j=25^\circ\text{C}$	$V_{RRM}$	V	1700
Reverse voltage (Surge peak) @ $T_j=25^\circ\text{C}$	$V_{RSM}$	V	1700
Reverse voltage (DC) @ $T_j=25^\circ\text{C}$	$V_{DC}$	V	1700
Continuous forward current @ $T_C=25^\circ\text{C}$	$I_F$	A	60
Continuous forward current @ $T_C=133^\circ\text{C}$			30
Continuous forward current @ $T_C=135^\circ\text{C}$			29.5
Non-repetitive peak forward surge current @ $T_C=25^\circ\text{C}$ , $t_p=10\text{ms}$ , Half Sine Wave	$I_{FSM}$	A	242
Power Dissipation@ $T_C=25^\circ\text{C}$	$P_{TOT}$	W	319
Power Dissipation@ $T_C=110^\circ\text{C}$			138
$i^2t$ Value@ $T_C=25^\circ\text{C}$ , $t_p=10\text{ms}$	$\int i^2 dt$	$\text{A}^2\text{S}$	292
Operating junction and Storage temperature range	$T_j, T_{stg}$	$^\circ\text{C}$	-55 to +175



## ■Electrical Characteristics

PARAMETER	SYMBOL	UNIT	TEST CONDITIONS	Typ.	Max.
Forward voltage drop	$V_F$	V	$I_F=30A, T_j=25^\circ C$	1.7	1.9
			$I_F=30A, T_j=175^\circ C$	3.0	-
Reverse leakage current	$I_R$	$\mu A$	$V_R=1700V, T_j=25^\circ C$	10	80
			$V_R=1700V, T_j=175^\circ C$	50	-
Total capacitive charge	$Q_C$	nC	$V_R=1700V, T_j=25^\circ C, Q_C=\int_0^{V_R} I_C(V)dV$	231	-
Total capacitance	C	pF	$V_R=0V, f=1MHZ$	2218	-
			$V_R=800V, f=1MHZ$	101	-
			$V_R=1700V, f=1MHZ$	93	-
Capacitance Stored Energy	$E_C$	$\mu J$	$V_R=1700V$	122	-

## ■Thermal Characteristics (Ta=25°C Unless otherwise specified)

PARAMETER	SYMBOL	UNIT	VALUE
Thermal resistance	$R_{\theta J-C}$	$^\circ C/W$	0.47

## ■Typical Characteristics

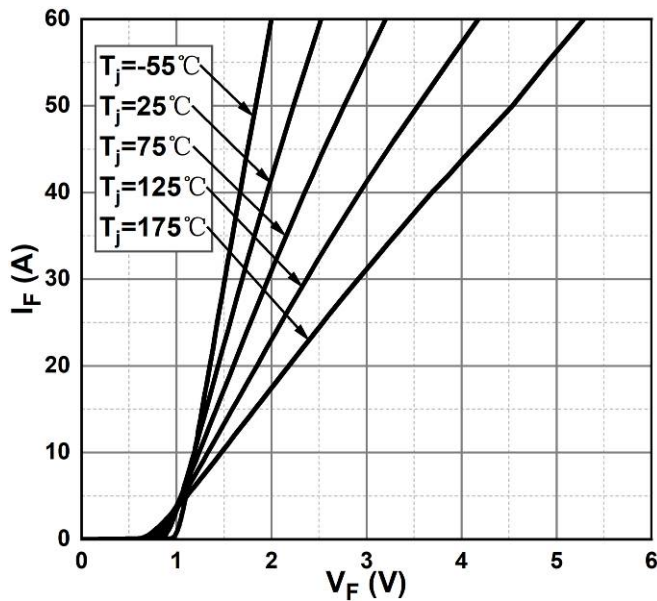

Figure 1. Forward Characteristics

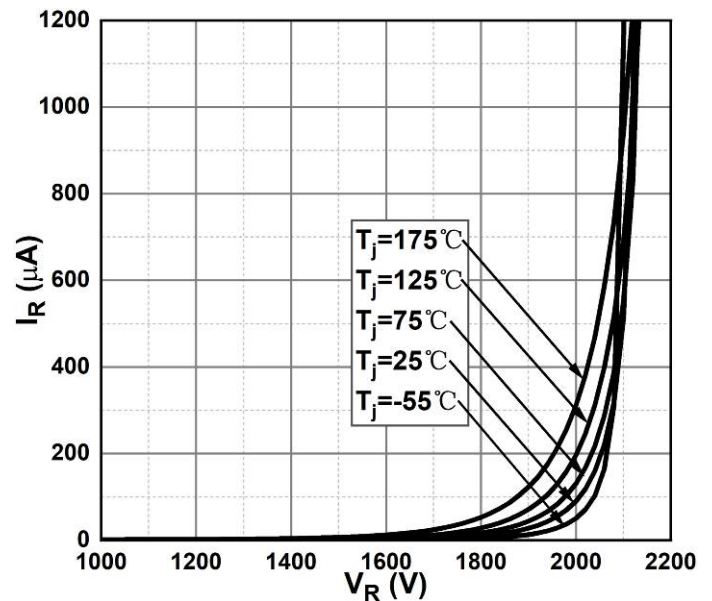

Figure 2. Reverse Characteristics

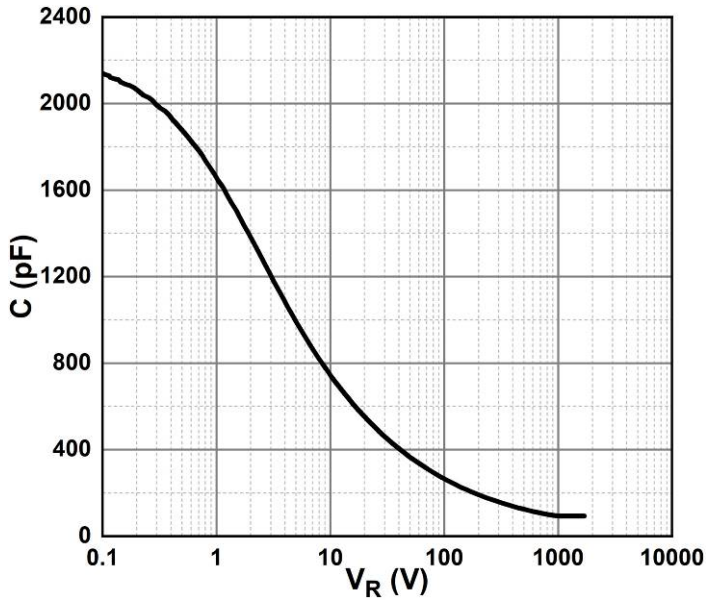

Figure 3. Capacitance vs. Reverse Voltage

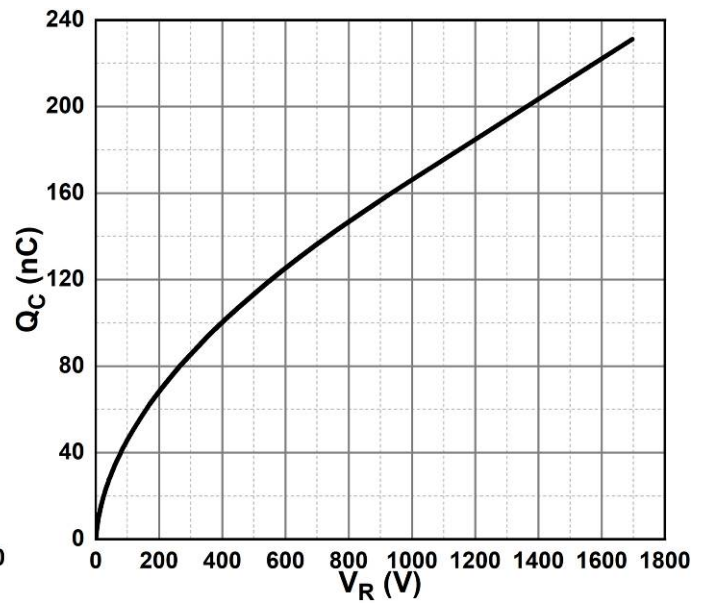

Figure 4. Total Capacitance Charge vs. Reverse Voltage

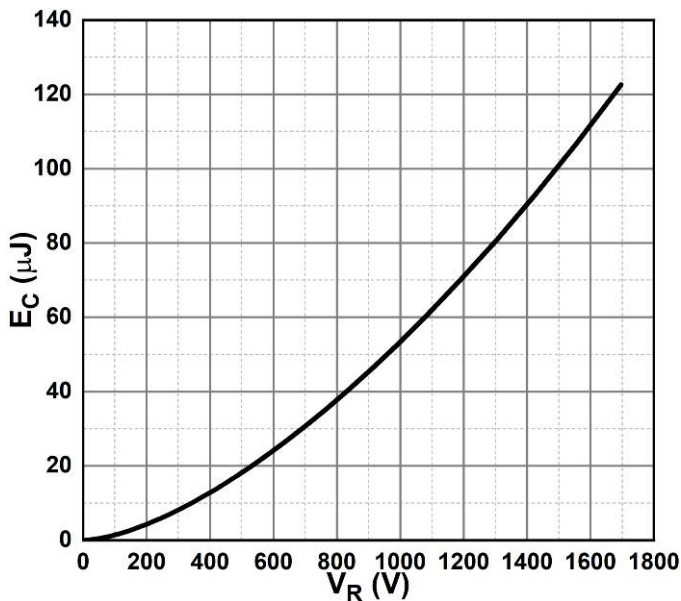

Figure 5. Capacitance Stored Energy

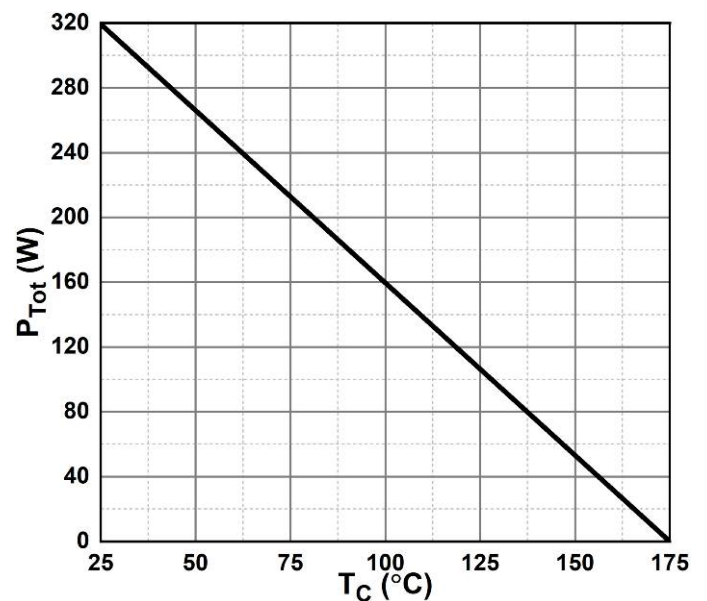

Figure 6. Power Derating

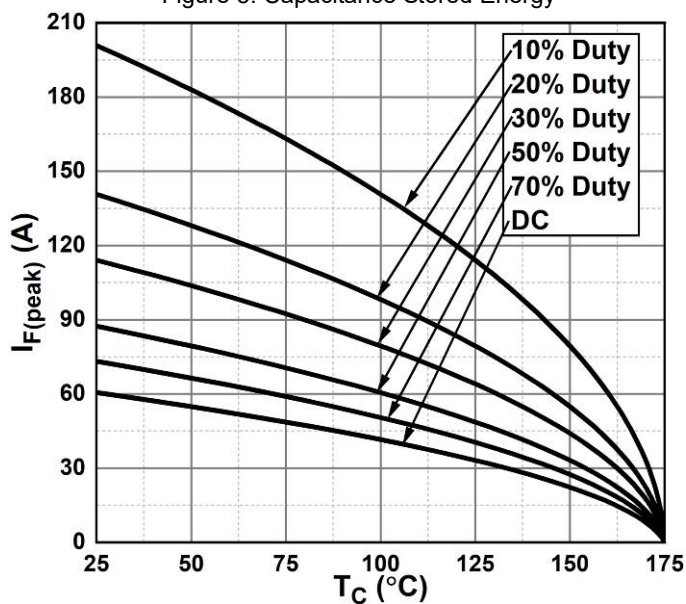

Figure 7. Current Derating

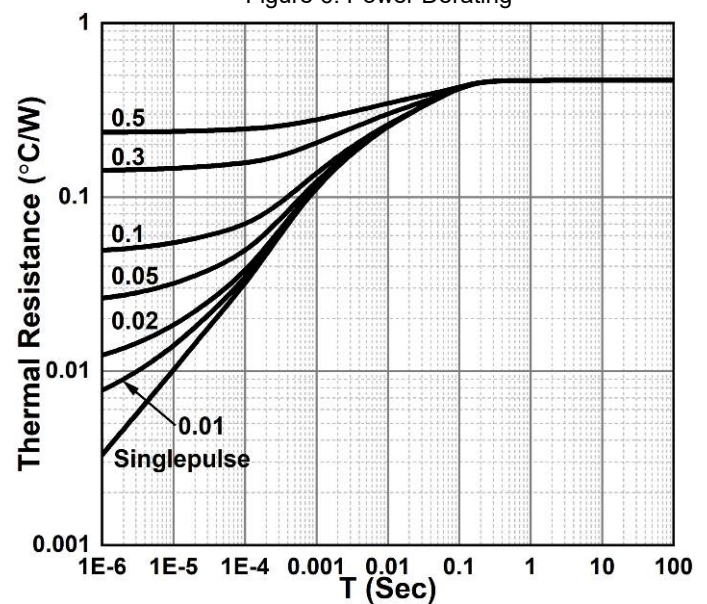
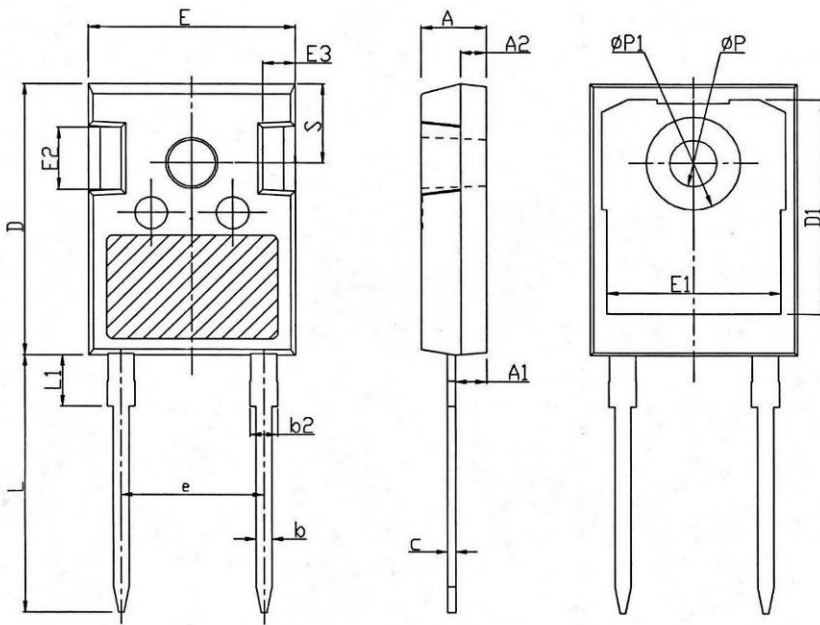

Figure 8. Transient Thermal Impedance

## ■Outline Dimensions

TO-247AC



TO-247AC		
Dim	Min	Max
A	4.80	5.20
A1	2.21	2.61
A2	1.85	2.15
b	1.11	1.36
b2	1.91	2.21
c	0.51	0.75
D	20.70	21.30
D1	16.25	16.85
E	15.50	16.10
E1	13.00	13.60
E2	4.80	5.20
E3	2.30	2.70
e	10.88BSC	
L	19.62	20.22
L1	-	4.30
$\phi P$	3.40	3.80
$\phi P1$	-	7.30
S	6.15BSC	



---

**Disclaimer**

The information presented in this document is for reference only. Yangzhou Yangjie Electronic Technology Co., Ltd. reserves the right to make changes without notice for the specification of the products displayed herein to improve reliability, function or design or otherwise.

The product listed herein is designed to be used with ordinary electronic equipment or devices, and not designed to be used with equipment or devices which require high level of reliability and the malfunction of which would directly endanger human life (such as medical instruments, transportation equipment, aerospace machinery, nuclear-reactor controllers, fuel controllers and other safety devices), Yangjie or anyone on its behalf, assumes no responsibility or liability for any damages resulting from such improper use of sale.

This publication supersedes & replaces all information previously supplied. For additional information, please visit our website [http:// www.21yangjie.com](http://www.21yangjie.com) , or consult your nearest Yangjie's sales office for further assistance.