

## IGBT Discrete

$V_{CE}$	<b>650</b>	<b>V</b>
$I_C$	<b>60</b>	<b>A</b>
$V_{CE(SAT)} I_C=60A$	<b>1.50</b>	<b>V</b>

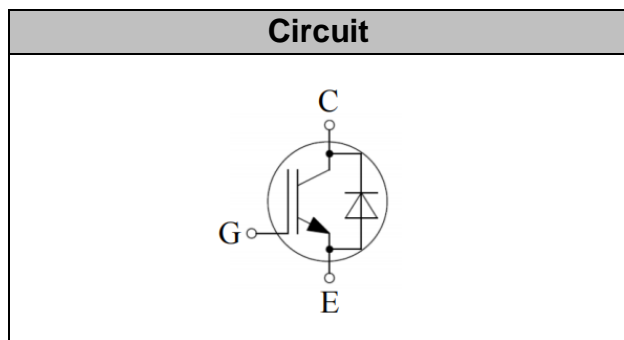

## Applications

- Solar converters
- Uninterruptible power supplies
- Welding converters
- Mid to high range switching frequency converters

## Features

- High speed smooth switching device for hard & soft switching
- Maximum junction temperature 175°C
- Positive temperature coefficient
- High ruggedness, temperature stable

## Maximum Ratings

Parameter	Symbol	Value	Unit
Collector-Emitter Breakdown Voltage	$V_{CE}$	650	V
DC Collector Current, limited by $T_{jmax}$ $T_C=25^\circ C$ value limited by bondwire $T_C=100^\circ C$	$I_C$	80 60	A
Diode Forward Current, limited by $T_{jmax}$ $T_C=25^\circ C$ value limited by bondwire $T_C=100^\circ C$	$I_F$	80 60	A
Continuous Gate-Emitter Voltage	$V_{GE}$	$\pm 20$	V
Transient Gate-Emitter Voltage ( $t_p \leq 10\mu s, D < 0.010$ )	$V_{GE}$	$\pm 30$	V
Turn off Safe Operating Area $V_{CE} \leq 650V$ , $T_j \leq 150^\circ C$		240	A
Pulsed Collector Current, $V_{GE}=15V$ , $t_p$ limited by $T_{jmax}$	$I_{CM}$	240	A
Diode Pulsed Current, $t_p$ limited by $T_{jmax}$	$I_{Fpuls}$	240	A
Power Dissipation, $T_j=175^\circ C, T_C=25^\circ C$	$P_{tot}$	283	W



Operating Junction Temperature	$T_j$	-40...+175	°C
Storage Temperature	$T_s$	-55...+150	°C
Soldering Temperature, wave soldering 1.6mm (0.063in.) from case for 10s		260	°C

**Electrical Characteristics of the IGBT** ( $T_j = 25^\circ\text{C}$  unless otherwise specified):

Parameter	Symbol	Conditions	Min.	Typ.	Max.	Unit
<b>Static</b>						
Collector-Emitter Breakdown Voltage	$BV_{CES}$	$V_{GE}=0V, I_C=250\mu A$	650		-	V
Gate Threshold Voltage	$V_{GE(th)}$	$V_{GE}=V_{CE}, I_C=0.50mA$	3.0	4.0	5.0	V
Collector-Emitter Saturation Voltage	$V_{CE(sat)}$	$V_{GE}=15V, I_C=60A$ $T_j=25^\circ\text{C}$ , $T_j=125^\circ\text{C}$ $T_j=150^\circ\text{C}$	1.20	1.50 1.70 1.80	1.80	V
Zero Gate Voltage Collector Current	$I_{CES}$	$V_{CE}=650V, V_{GE}=0V$ $T_j=25^\circ\text{C}$ , $T_j=150^\circ\text{C}$			0.25 3.00	mA
Gate-Emitter Leakage Current	$I_{GES}$	$V_{CE}=0V, V_{GE}=\pm 20V$			100	nA

Parameter	Symbol	Conditions	Min.	Typ.	Max.	Unit
<b>Dynamic</b>						
Input Capacitance	$C_{ies}$	$V_{CE}=25V, V_{GE}=0V,$ $f=1MHz$	-	2.86	-	nF
Reverse Transfer Capacitance	$C_{res}$		-	0.02	-	
Gate Charge	$Q_G$	$V_{CC}=520V, I_C=60A,$ $V_{GE}=15V$	-	0.18	-	uC

**Electrical Characteristics of the Diode** ( $T_j = 25^\circ\text{C}$  unless otherwise specified):

Parameter	Symbol	Conditions	Min.	Typ.	Max.	Unit
<b>Static</b>						
Diode Forward Voltage	$V_F$	$I_F = 60\text{A}$ $T_j = 25^\circ\text{C}$ , $T_j = 125^\circ\text{C}$ $T_j = 150^\circ\text{C}$		1.70 1.60 1.50	2.10	V

**Switching Characteristic, Inductive Load**

Parameter	Symbol	Conditions	Min.	Typ.	Max.	Unit
<b>Dynamic , at <math>T_j = 25^\circ\text{C}</math></b>						
Turn-on Delay Time	$t_{d(on)}$	$V_{CC} = 400\text{V}$ , $I_C = 60\text{A}$ , $V_{GE} = -5\text{V} \sim 15\text{V}$ , $R_g = 10\Omega$ , Inductive Load	-	27	-	ns
Rise Time	$t_r$		-	41	-	ns
Turn-on Energy	$E_{on}$		-	2.47	-	mJ
Turn-off Delay Time	$t_{d(off)}$		-	81	-	ns
Fall Time	$t_f$		-	45	-	ns
Turn-off Energy	$E_{off}$		-	0.67	-	mJ
Total switching energy	$E_{ts}$		-	3.14	-	mJ
<b>Dynamic , at <math>T_j = 125^\circ\text{C}</math></b>						
Turn-on Delay Time	$t_{d(on)}$	$V_{CC} = 400\text{V}$ , $I_C = 60\text{A}$ , $V_{GE} = -5\text{V} \sim 15\text{V}$ , $R_g = 10\Omega$ , Inductive Load	-	28	-	ns
Rise Time	$t_r$		-	49	-	ns
Turn-on Energy	$E_{on}$		-	2.53	-	mJ
Turn-off Delay Time	$t_{d(off)}$		-	88	-	ns
Fall Time	$t_f$		-	57	-	ns
Turn-off Energy	$E_{off}$		-	0.89	-	mJ
Total switching energy	$E_{ts}$		-	3.42	-	mJ
<b>Dynamic , at <math>T_j = 150^\circ\text{C}</math></b>						
Turn-on Delay Time	$t_{d(on)}$	$V_{CC} = 400\text{V}$ , $I_C = 60\text{A}$ , $V_{GE} = -5\text{V} \sim 15\text{V}$ , $R_g = 10\Omega$ , Inductive Load	-	29	-	ns
Rise Time	$t_r$		-	52	-	ns
Turn-on Energy	$E_{on}$		-	2.57	-	mJ
Turn-off Delay Time	$t_{d(off)}$		-	93	-	ns
Fall Time	$t_f$		-	66	-	ns
Turn-off Energy	$E_{off}$		-	0.93	-	mJ
Total switching energy	$E_{ts}$		-	3.50	-	mJ



## Electrical Characteristics of the DIODE

Parameter	Symbol	Conditions	Min.	Typ.	Max.	Unit
<b>Dynamic , at T<sub>j</sub>= 25°C</b>						
Reverse Recovery Current	I <sub>rr</sub>	I <sub>F</sub> =60A, V <sub>R</sub> =400V -di/dt=460A/μs,	-	16	-	A
Reverse Recovery Charge	Q <sub>rr</sub>		-	1.76	-	uC
Diode reverse recovery time	t <sub>rr</sub>		-	155	-	ns
Reverse Recovery Energy	E <sub>rec</sub>		-	0.34	-	mJ
<b>Dynamic , at T<sub>j</sub>= 125°C</b>						
Reverse Recovery Current	I <sub>rr</sub>	I <sub>F</sub> =60A, V <sub>R</sub> =400V -di/dt=460A/μs,	-	22	-	A
Reverse Recovery Charge	Q <sub>rr</sub>		-	2.83	-	uC
Diode reverse recovery time	t <sub>rr</sub>		-	196	-	ns
Reverse Recovery Energy	E <sub>rec</sub>		-	0.71	-	mJ
<b>Dynamic , at T<sub>j</sub>= 150°C</b>						
Reverse Recovery Current	I <sub>rr</sub>	I <sub>F</sub> =60A, V <sub>R</sub> =400V -di/dt=460A/μs,	-	25	-	A
Reverse Recovery Charge	Q <sub>rr</sub>		-	3.66	-	uC
Diode reverse recovery time	t <sub>rr</sub>		-	227	-	ns
Reverse Recovery Energy	E <sub>rec</sub>		-	0.85	-	mJ

## Thermal Resistance

Parameter	Symbol	Max. Value	Unit
IGBT Thermal Resistance, Junction - Case	R <sub>th(j-c)</sub>	0.53	K/W
Diode Thermal Resistance, Junction - Case	R <sub>th(j-c)</sub>	1.05	K/W
Thermal Resistance, Junction - Ambient	R <sub>th(j-a)</sub>	40	K/W

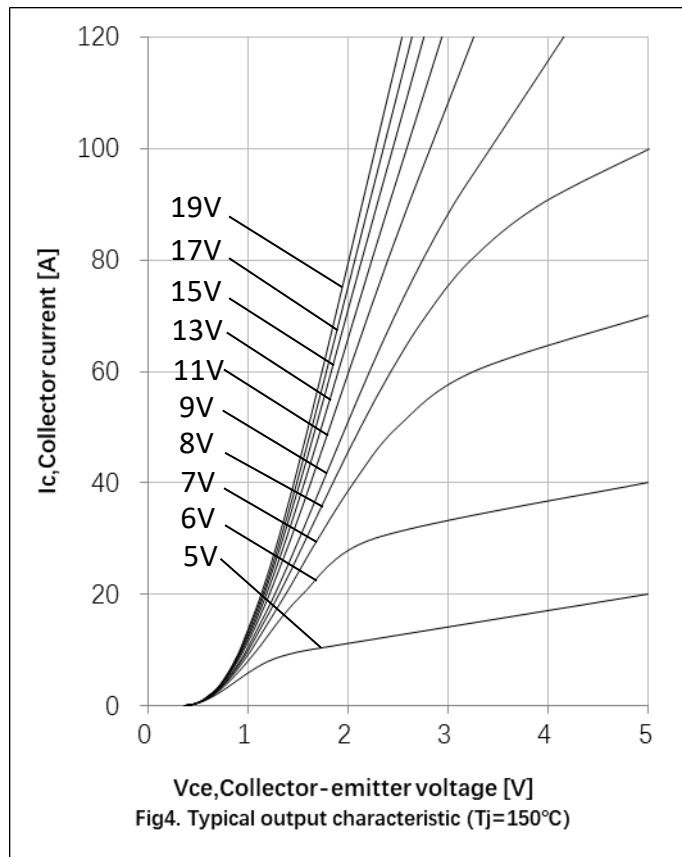
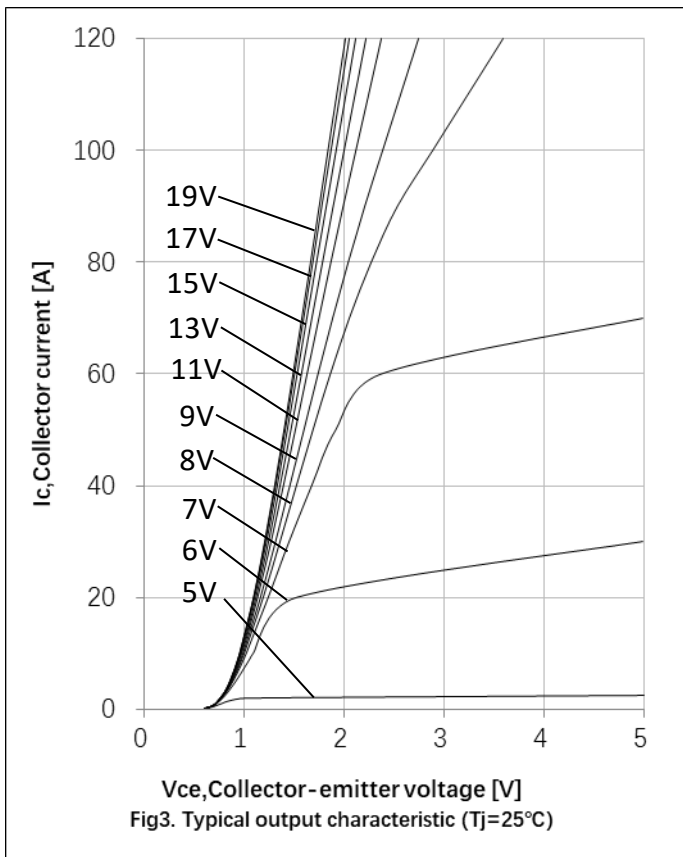
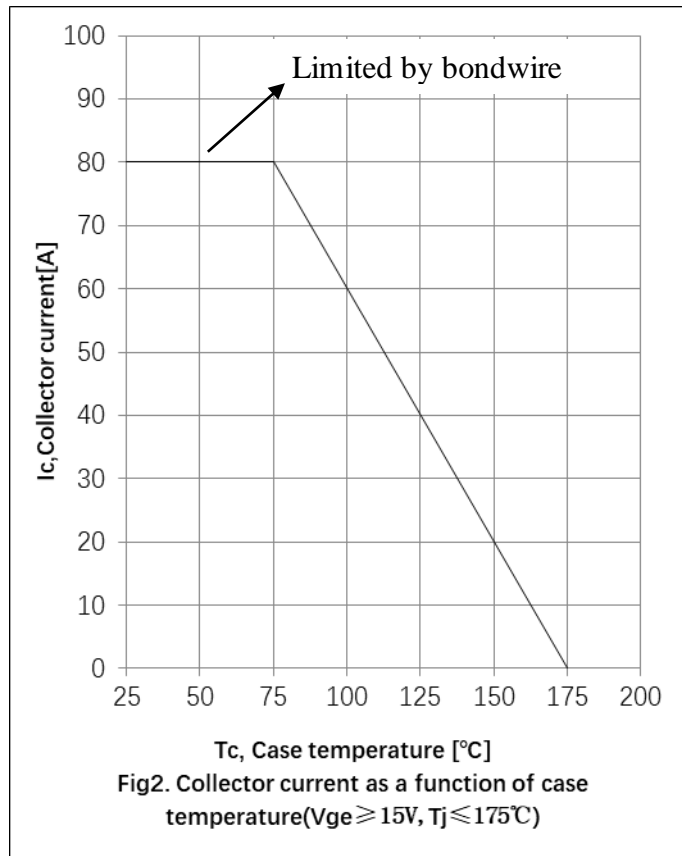
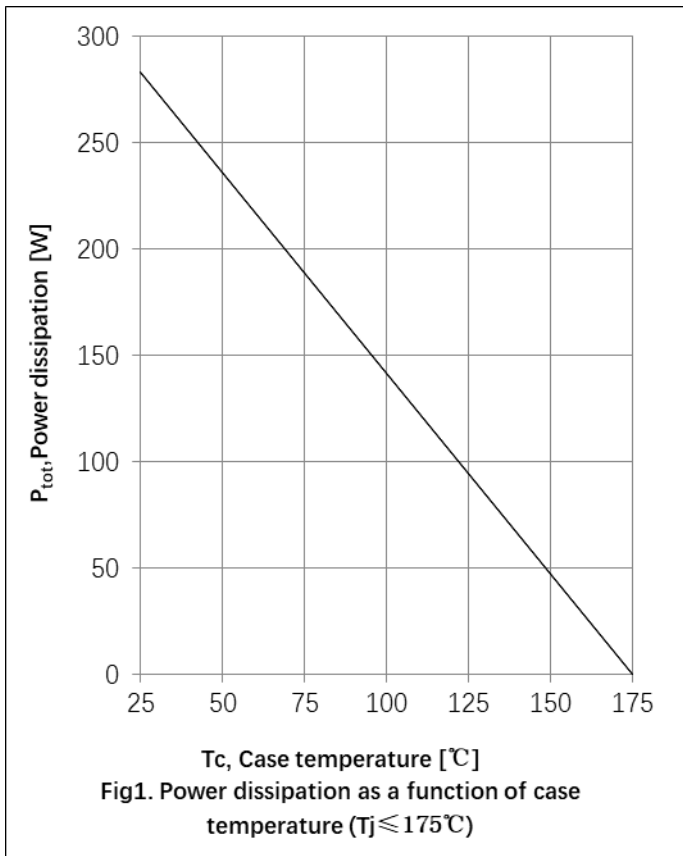

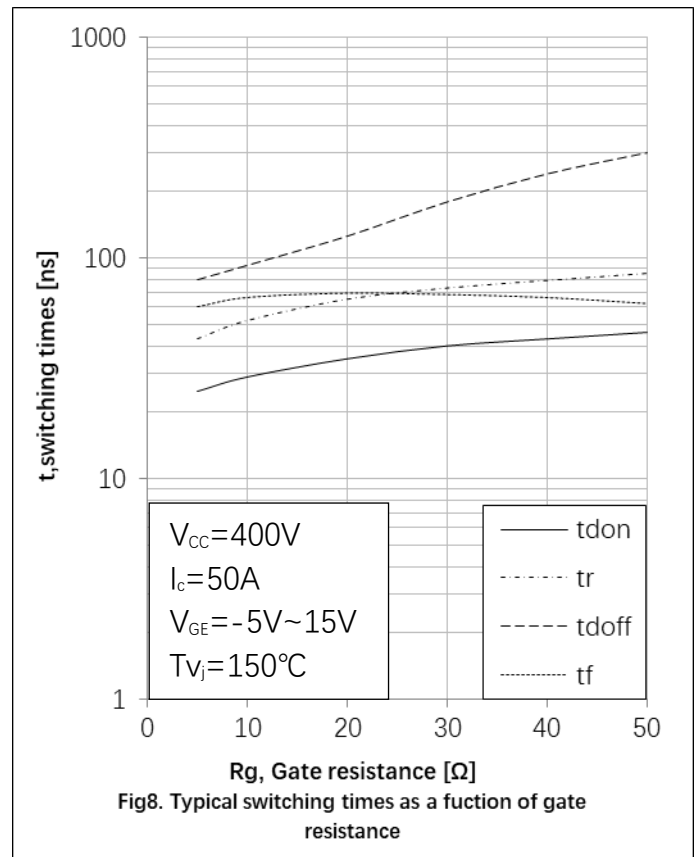
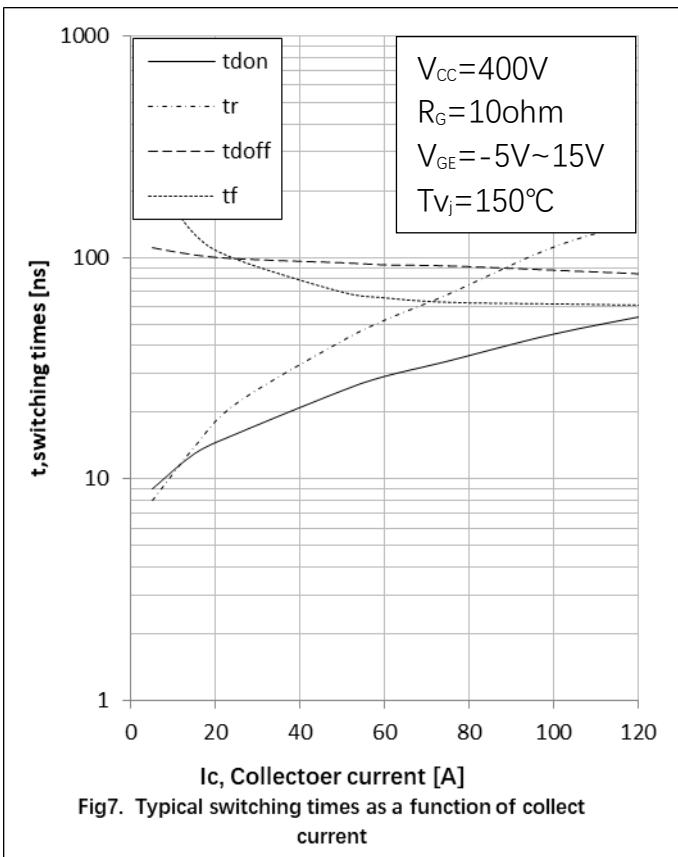
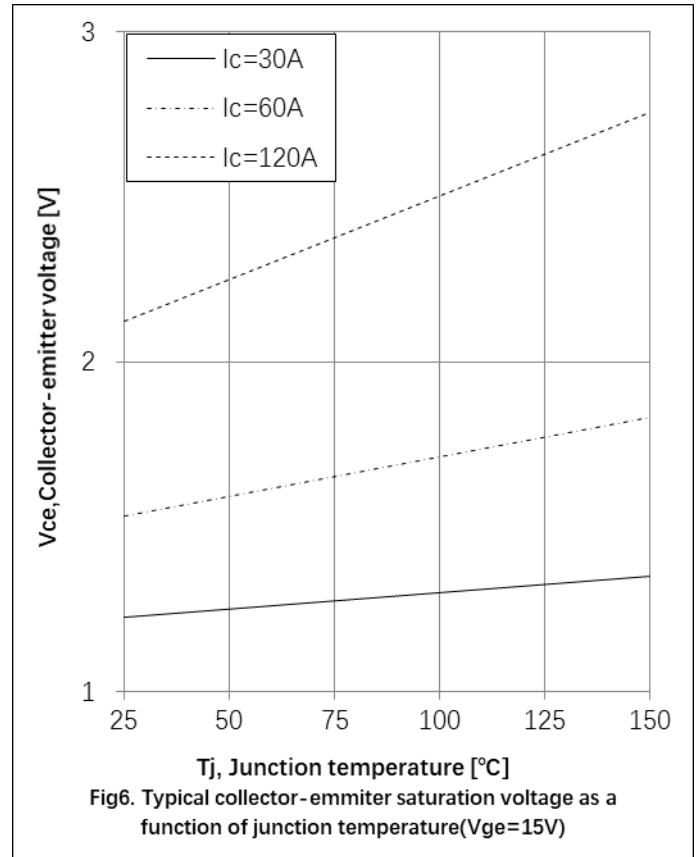
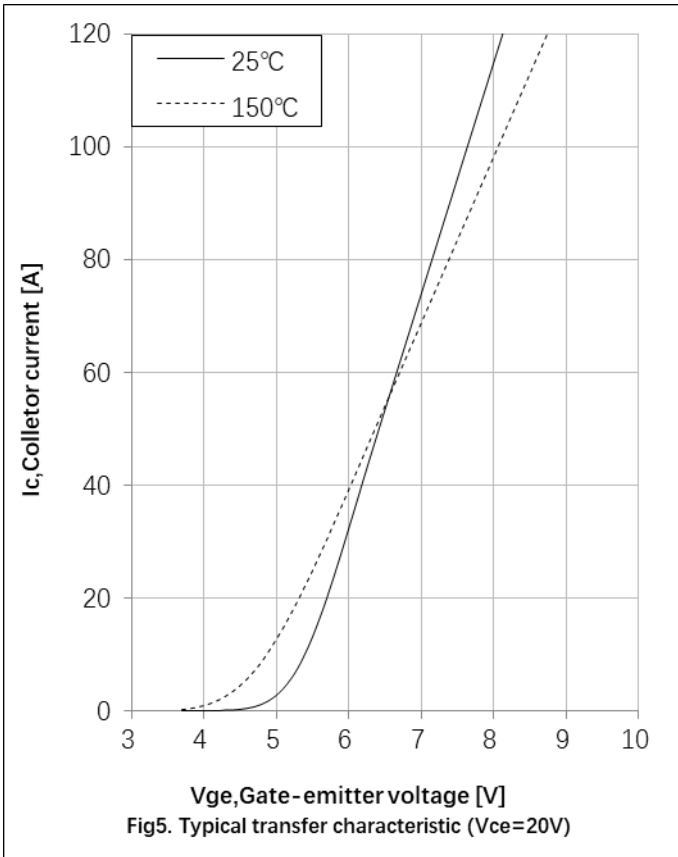

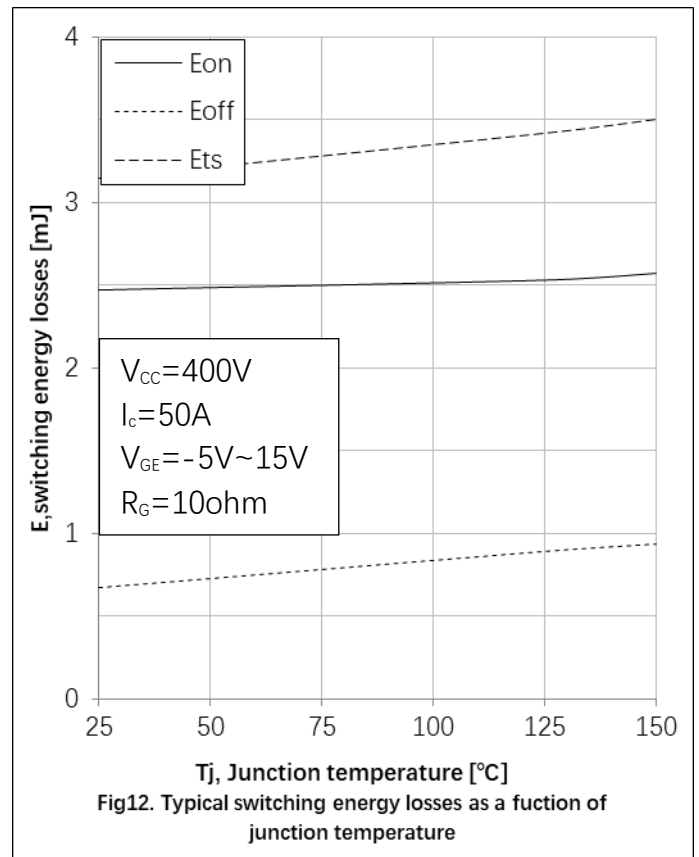
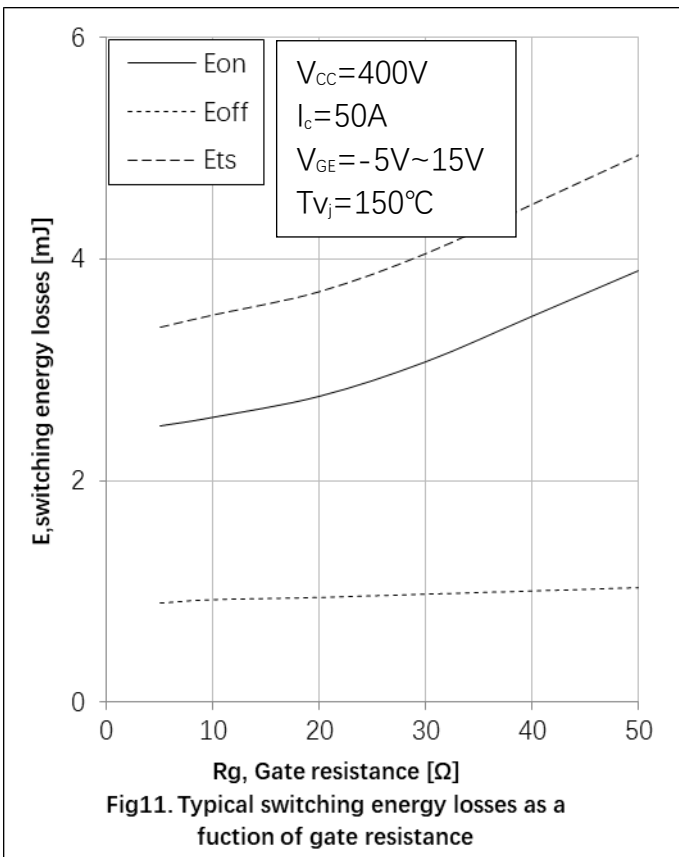
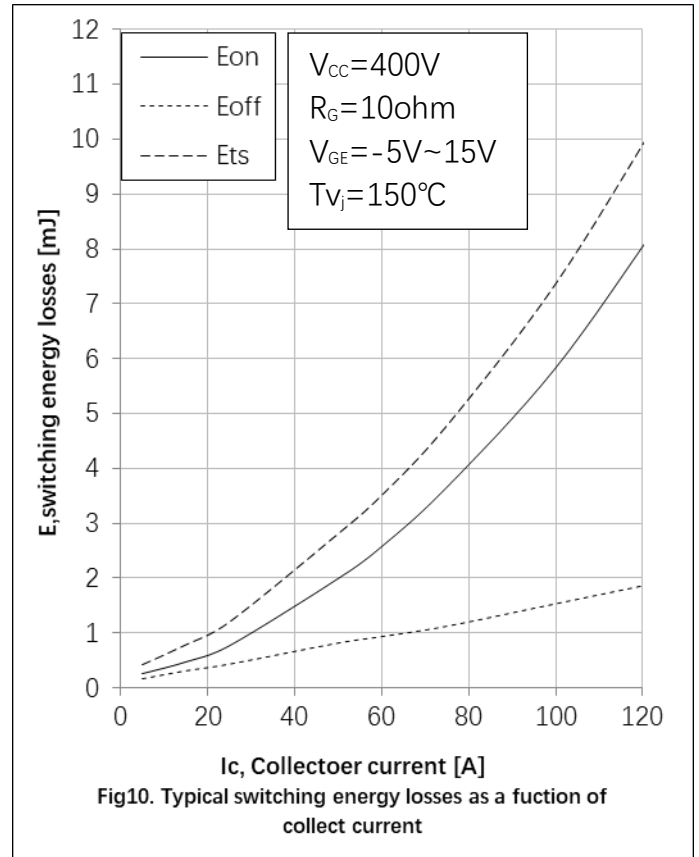
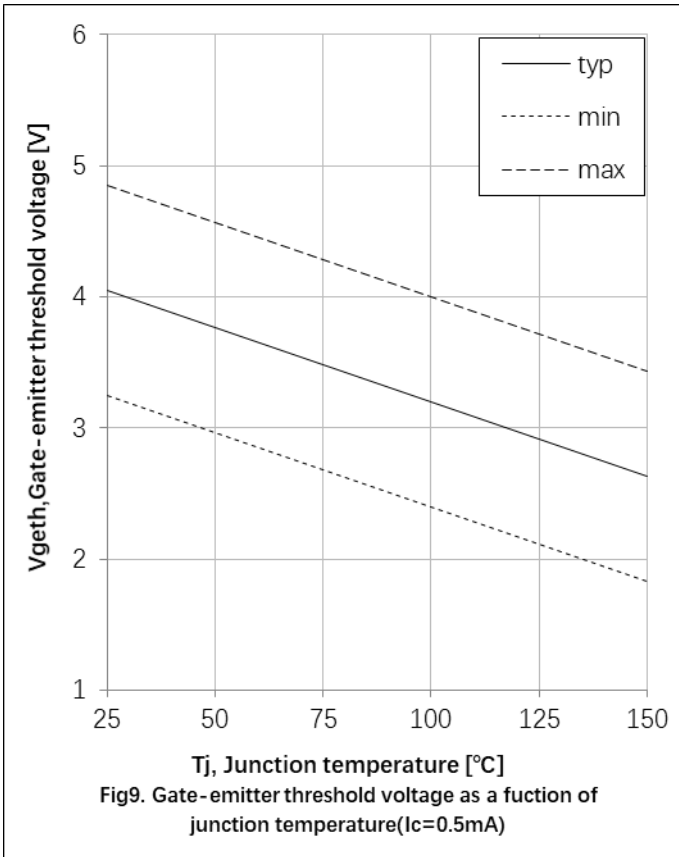

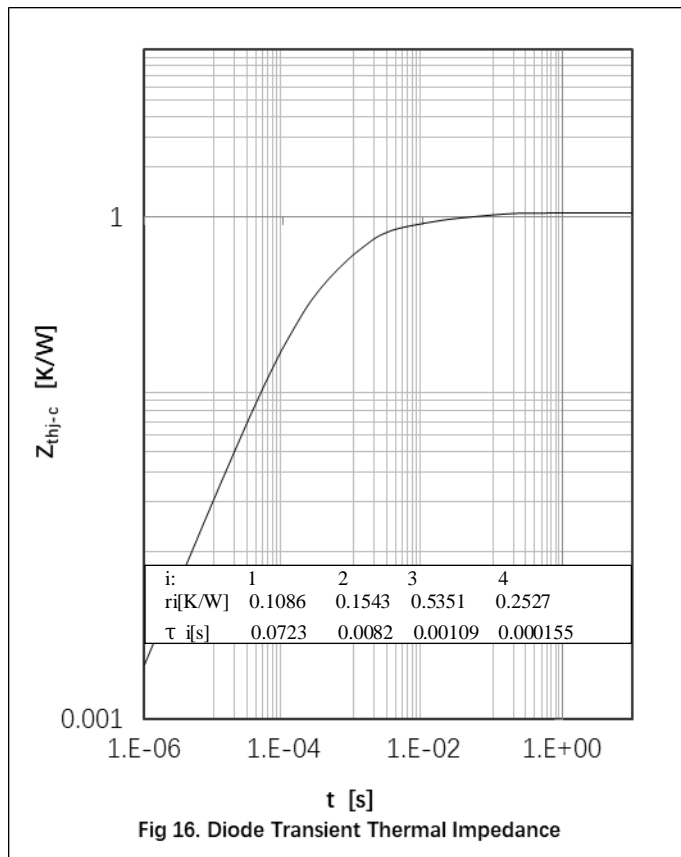
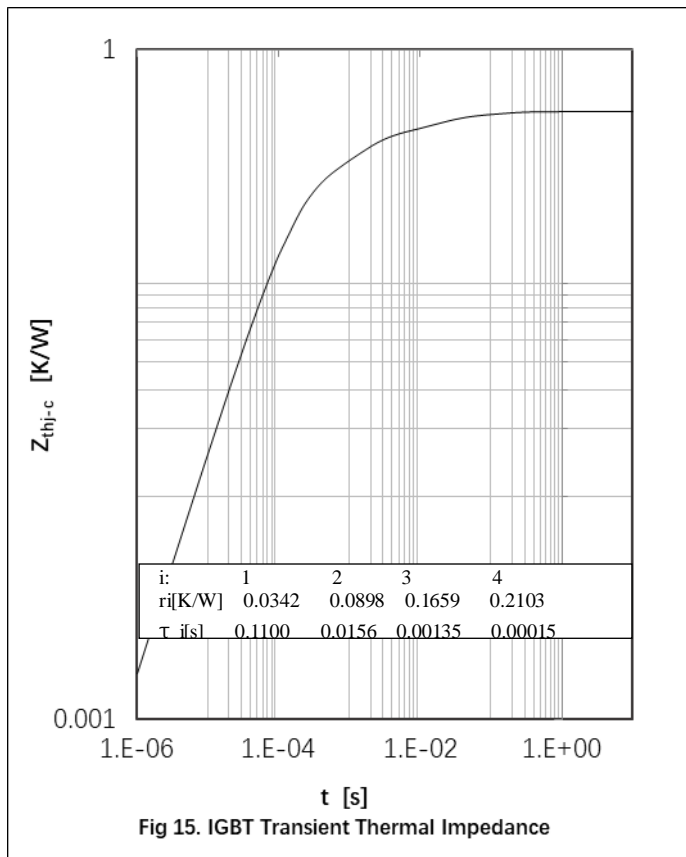
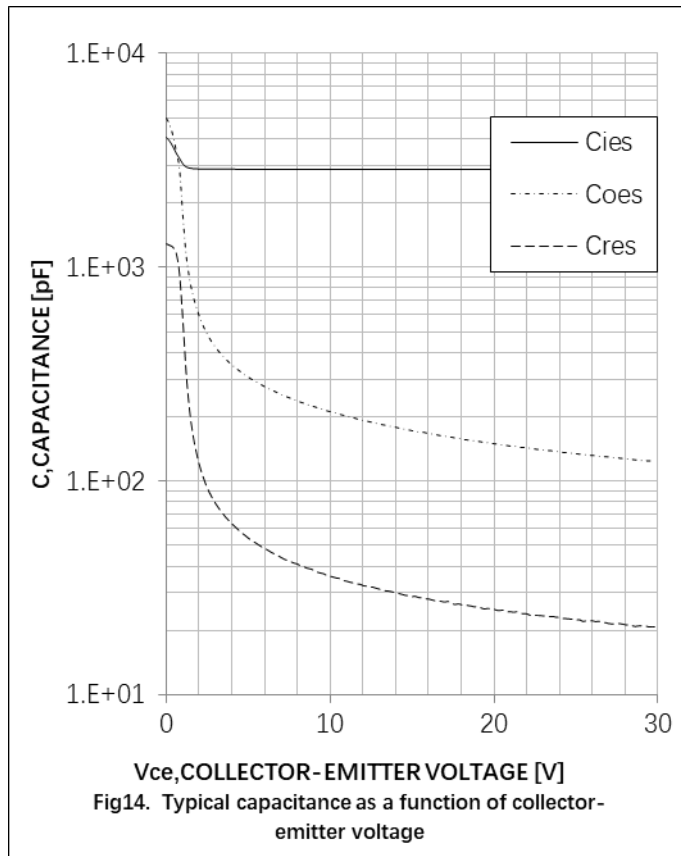
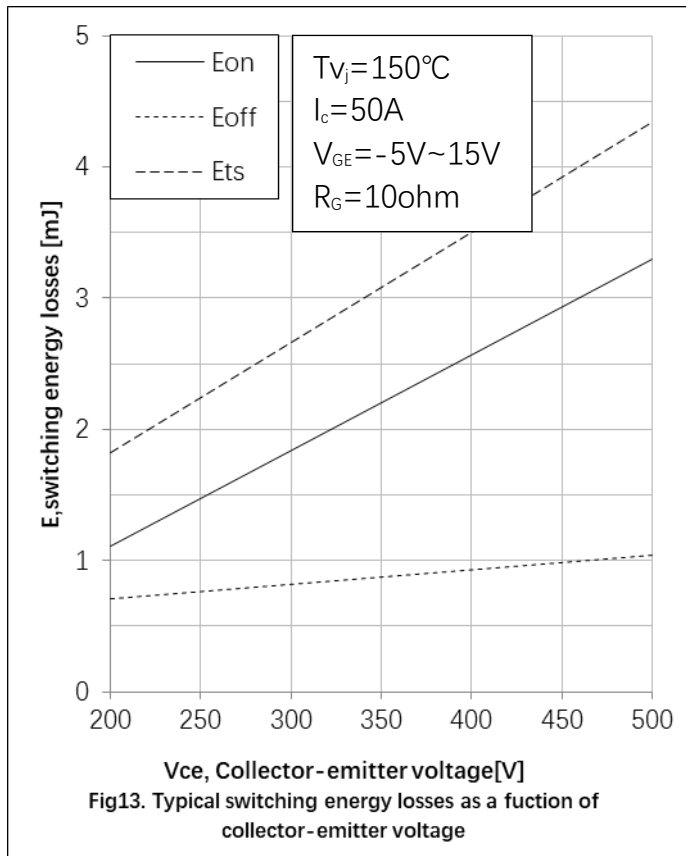



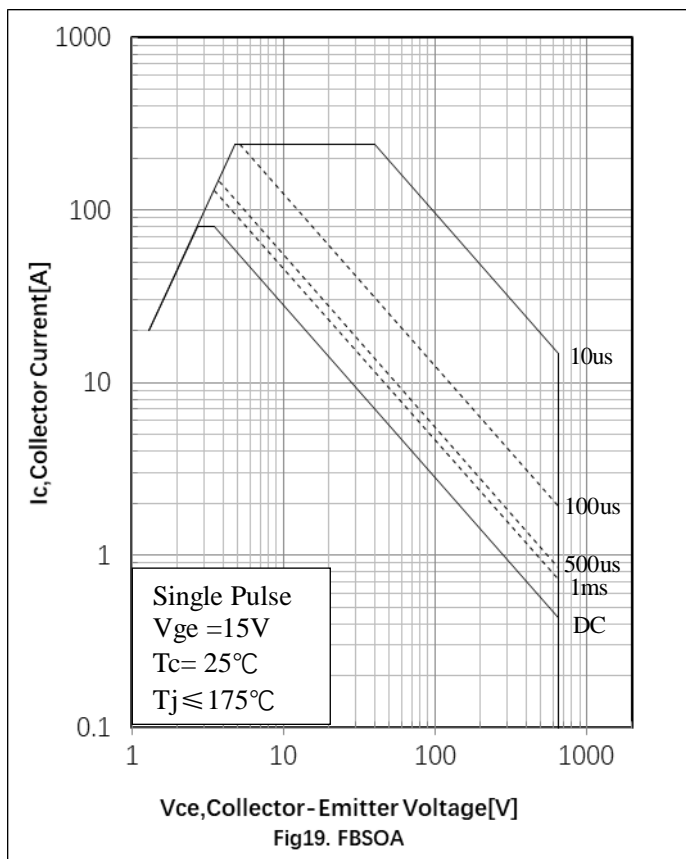
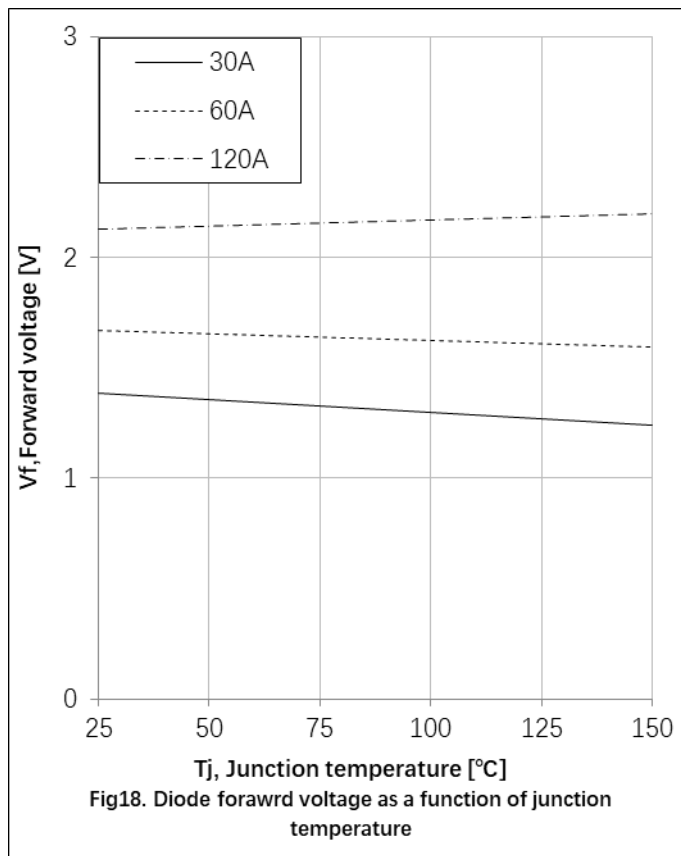
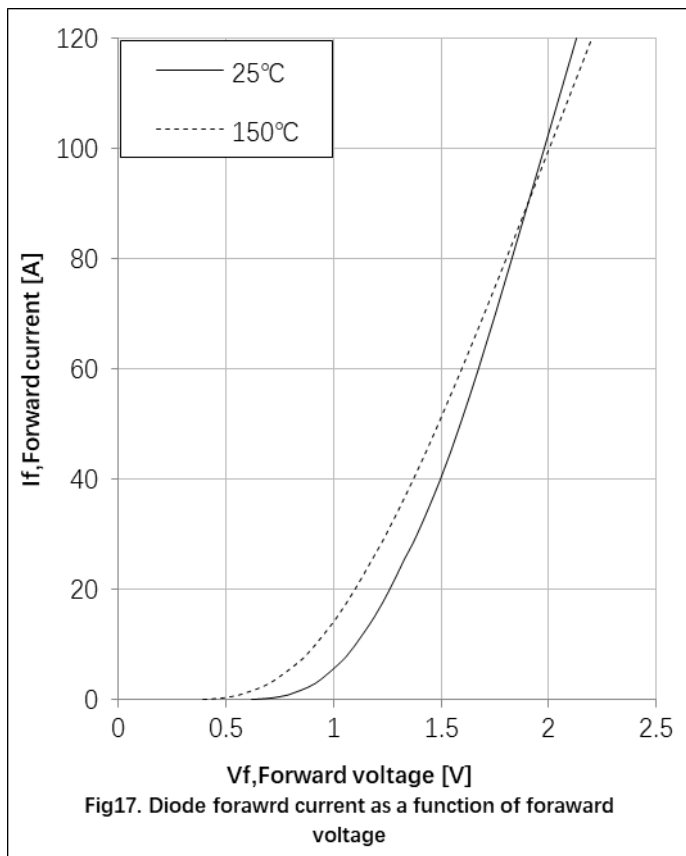

## ● Circuit Diagram

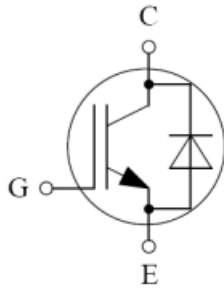

## ● Package Outline Information

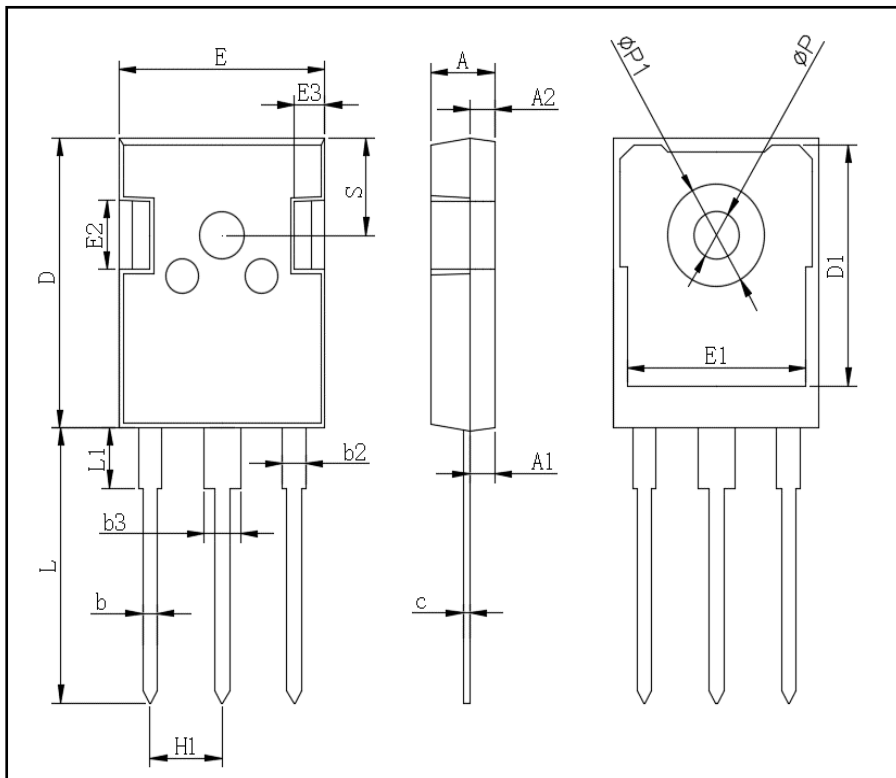

TO-247AB		
Dim	Min	Max
A	4.80	5.20
A1	2.21	2.61
A2	1.85	2.15
b	1.0	1.4
b2	1.91	2.21
C	0.5	0.7
D	20.70	21.30
D1	16.25	16.85
E	15.50	16.10
E1	13.0	13.6
E2	4.80	5.20
E3	2.30	2.70
L	19.62	20.22
L1	-	4.30
Φ P	3.40	3.80
Φ P1	-	7.30
S	6.15TYP	
H1	5.44TYP	
b3	2.80	3.20



# DGW60N65CTS2A

**RoHS**  
COMPLIANT

ISSUE	REVISION	DATE
1.0	Add Datasheet	19-Oct-23

## Marking Information

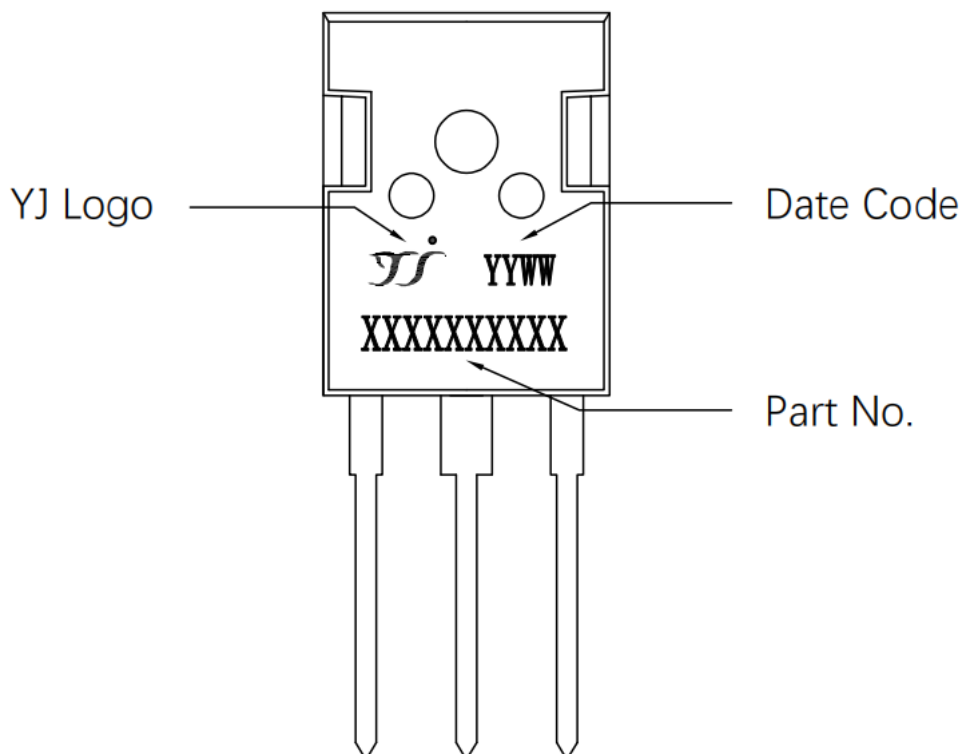

## Package Parameters

Base Part Number	Package Type	Standard Pack		Orderable Part Number
		Form	Quantity	
DGW60N65CTS2A	TO-247	Tube	30	DGW60N65CTS2A

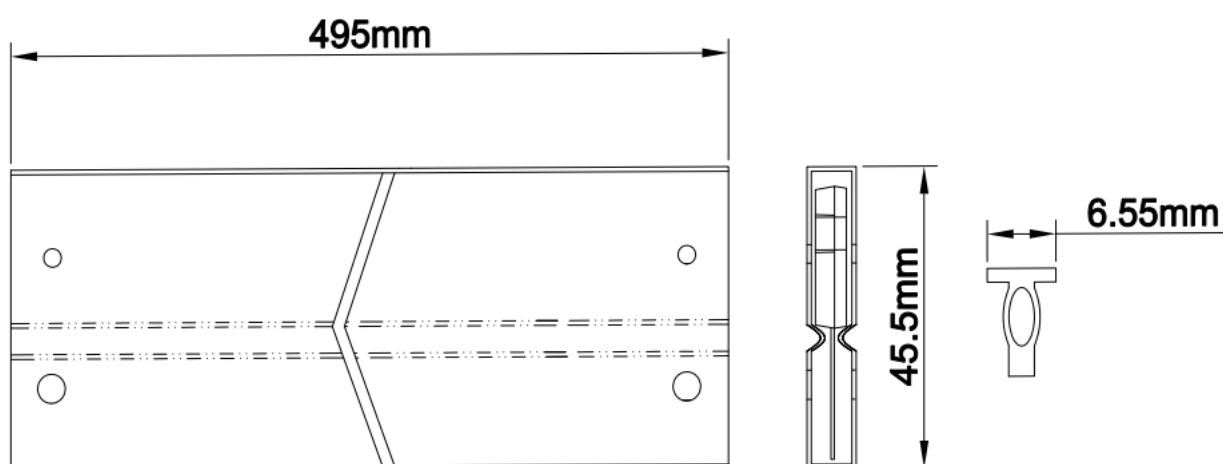



## Disclaimer

The information presented in this document is for reference only. Yangzhou Yangjie Electronic Technology Co., Ltd. reserves the right to make changes without notice for the specification of the products displayed herein to improve reliability, function or design or otherwise.

The product listed herein is designed to be used with ordinary electronic equipment or devices, and not designed to be used with equipment or devices which require high level of reliability and the malfunction of which would directly endanger human life (such as aerospace machinery, nuclear-reactor controllers, fuel controllers and other safety devices), Yangjie or anyone on its behalf, assumes no responsibility or liability for any damages resulting from such improper use of sale. This publication supersedes & replaces all information previously supplied. For additional information, please visit our website [http:// www.21yangjie.com](http://www.21yangjie.com) , or consult your nearest Yangjie's sales office for further assistance.